

DO NOT SCALE UNLESS STATED - IF IN DOUBT ASK

Material	
Qty Req'd	

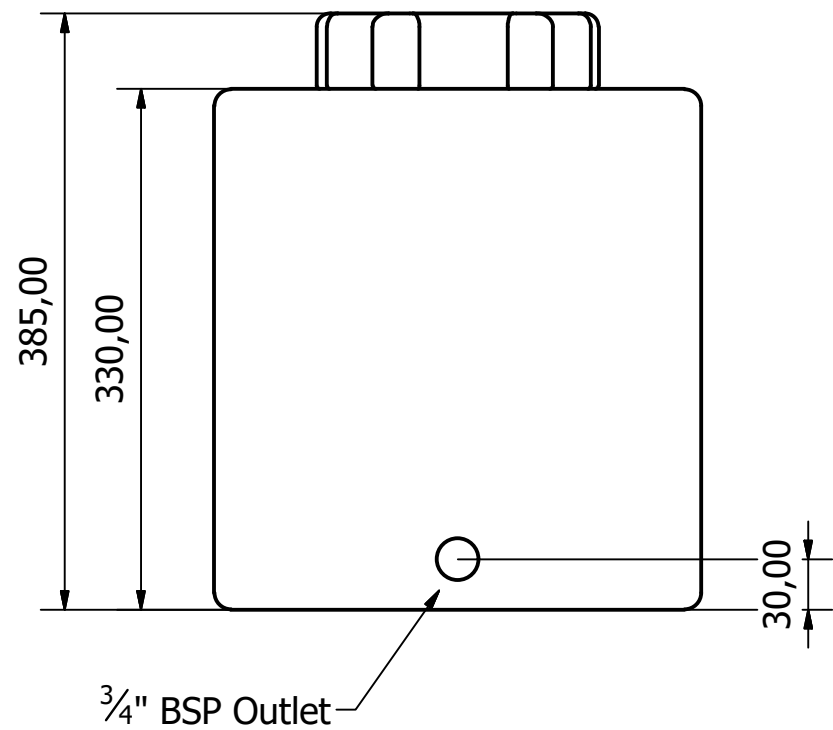
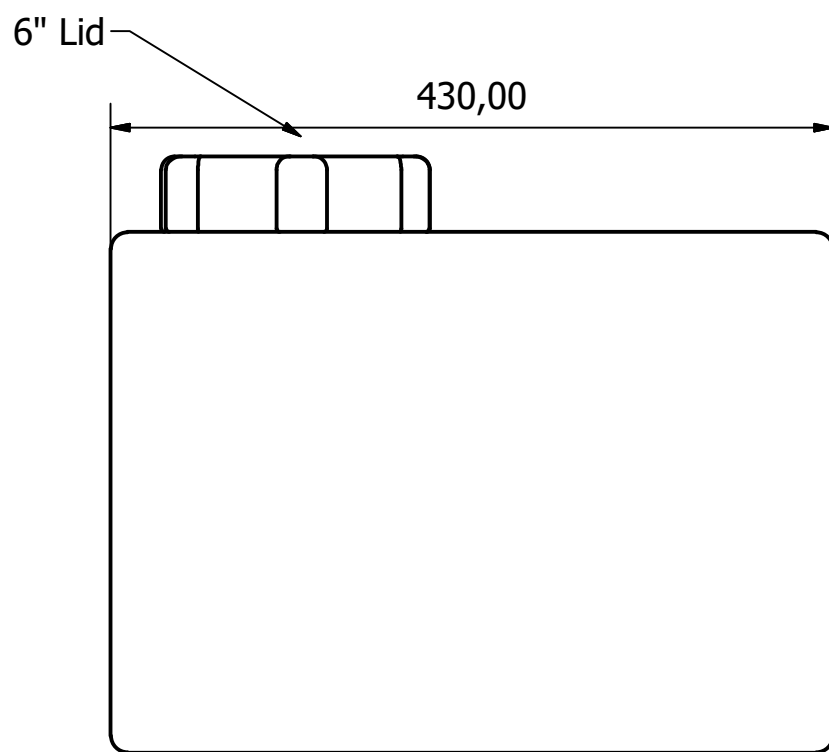
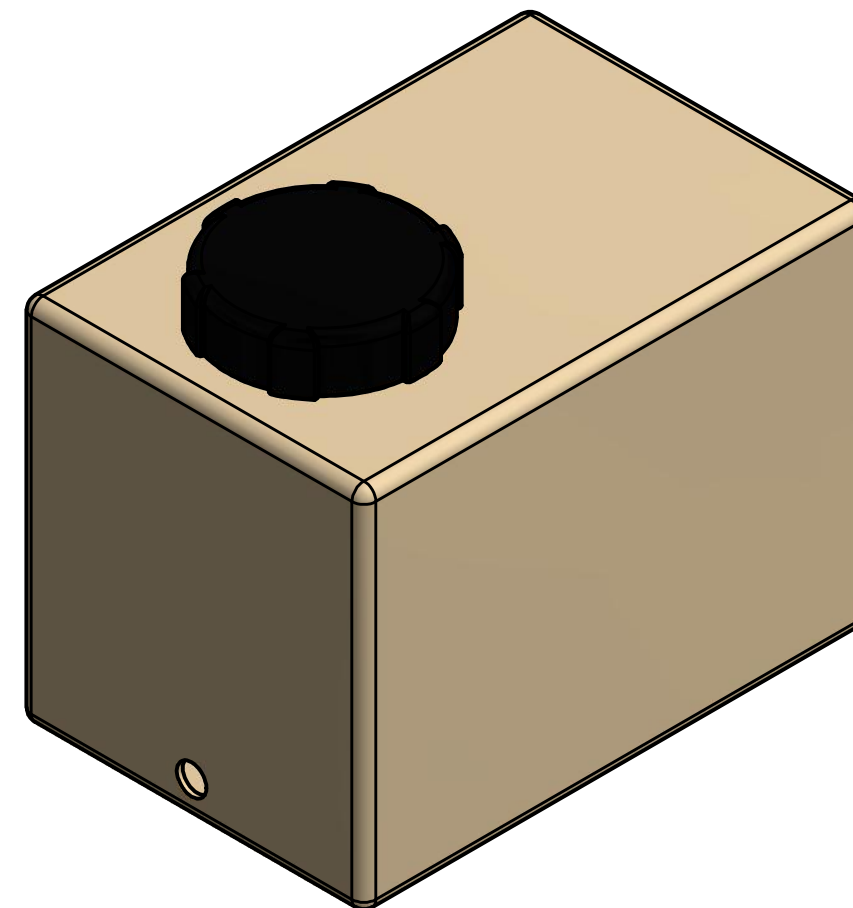
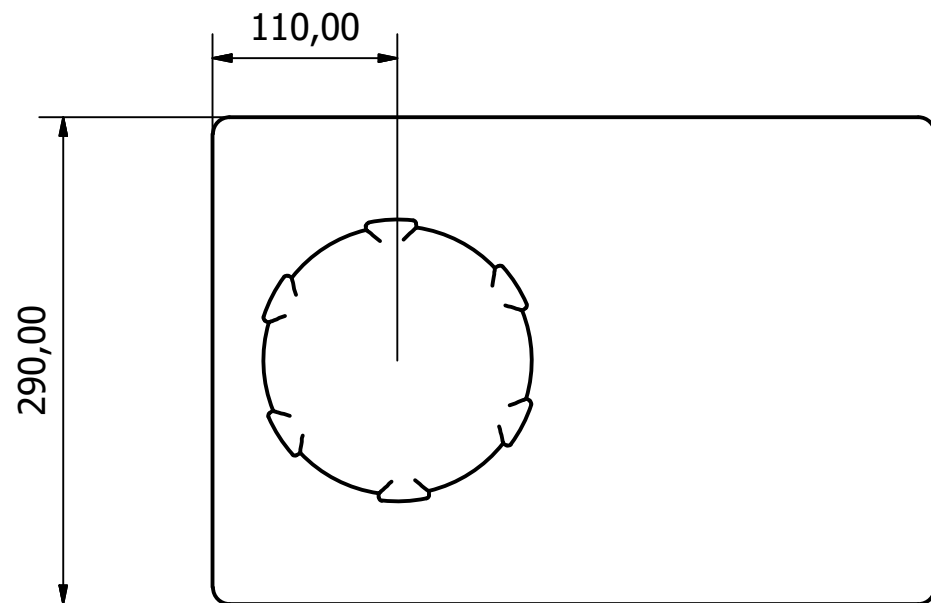

**wydale**  
 Wydale Plastics Ltd  
 Cathole Bridge Rd,  
 Crewkerne,  
 Somerset,  
 TA18 8RF  
 Tel: 01460 73212  
 Fax: 01460 77348

THIS DRAWING AND THE INFORMATION THEREON IS THE SOLE PROPERTY OF WYDALE PLASTICS LTD AND SHALL NOT BE COPIED OR REPRODUCED WITHOUT THE CONSENT OF WYDALE PLASTICS LTD. DIMENSIONS ARE ALL IN MM UNLESS OTHERWISE STATED.  
 ALL TOLERANCES +/- 3% UNLESS STATED.

CUSTOMER: Wydale Plastics Ltd	
PROJECT: 36 Litre Tank	
DRAWN DATE: 01/06/2018	DESIGNED BY: joshv
CHECKED BY:	
SHEET 1 OF 1	REV A
DRAWING NO:	

REV	ZONE	DESCRIPTION	DATE

