

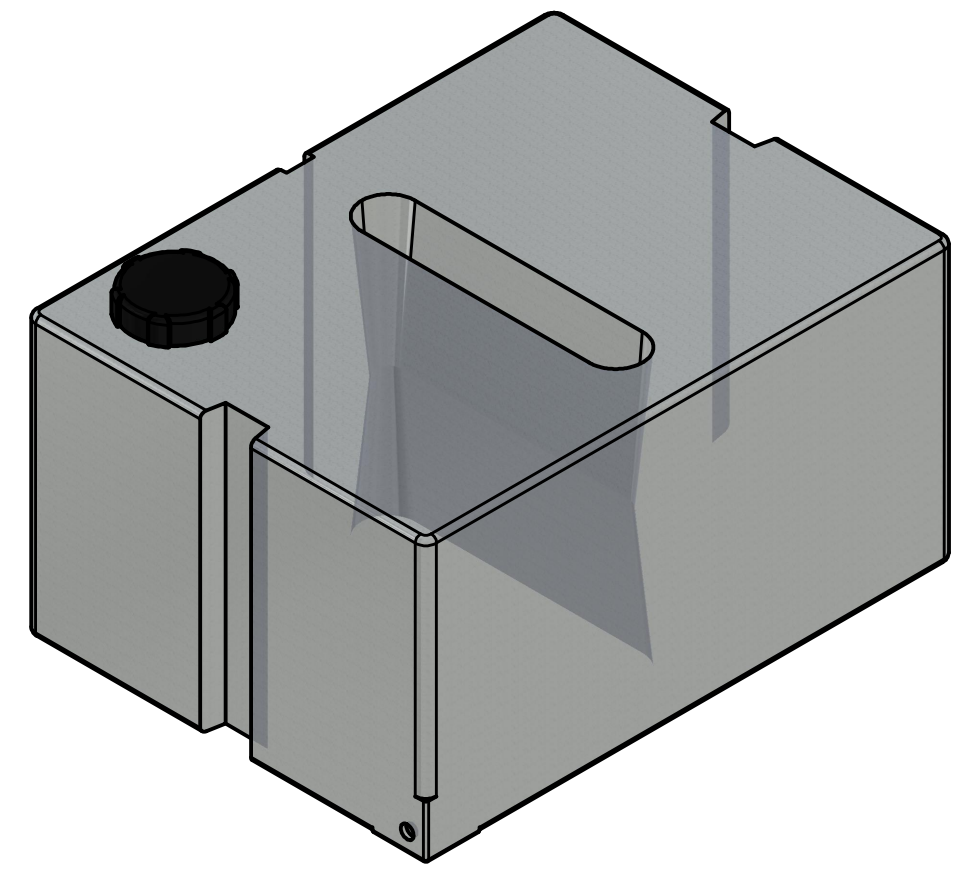

MATERIALS	Polyethylene
NOMINAL WEIGHT (kg)	24
TYPICAL WALL THICKNESS (mm)	6.7

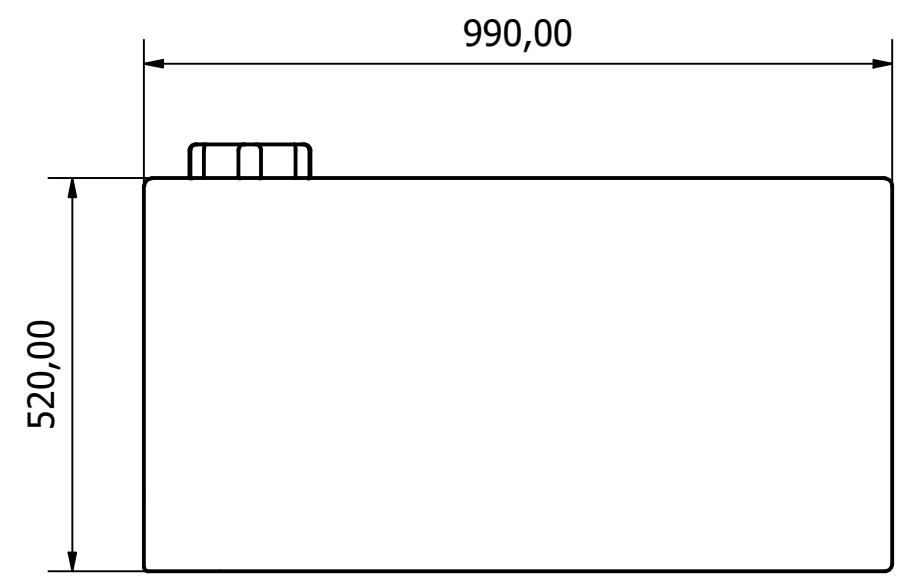
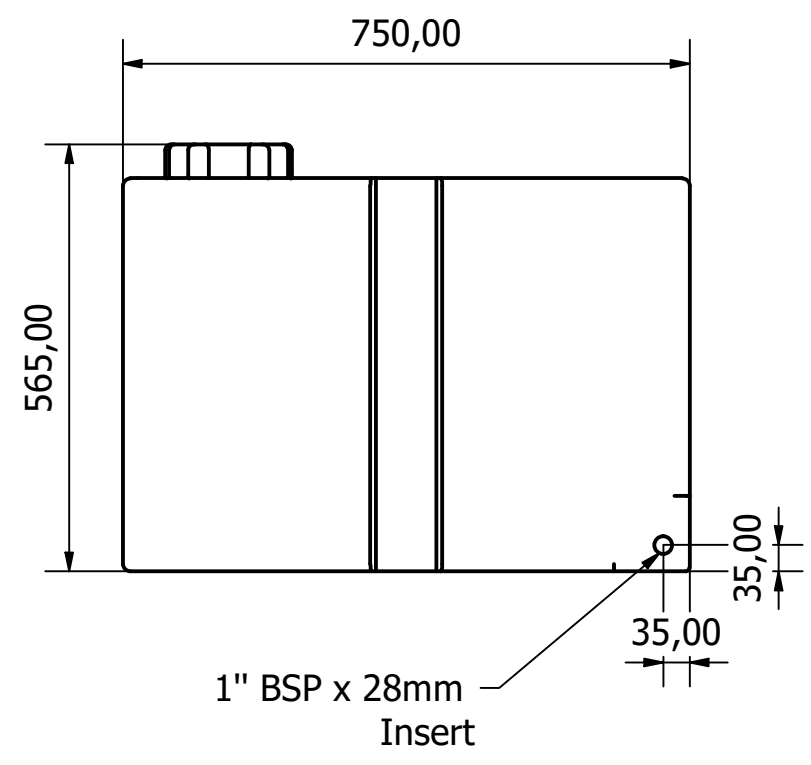
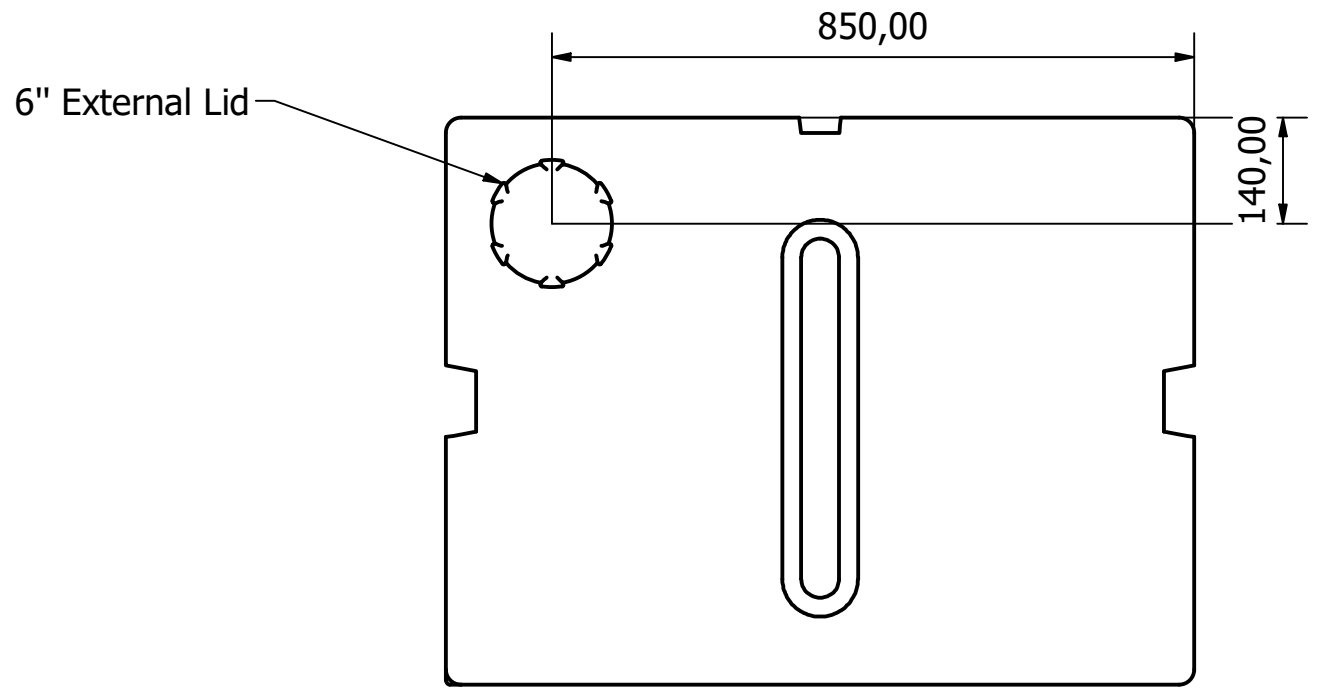

 <p>Wydale Plastics Ltd Cathole Bridge Rd, Crewkerne, Somerset, TA18 8RF Tel: 01460 73212 wydaleplastics.co.uk</p> <p><small>THIS DRAWING AND THE INFORMATION THEREIN IS THE SOLE PROPERTY OF WYDALE PLASTICS LTD AND SHALL NOT BE COPIED OR REPRODUCED WITHOUT THE CONSENT OF WYDALE PLASTICS LTD. DIMENSIONS ARE ALL IN MM UNLESS OTHERWISE STATED. WHILST EVERY EFFORT IS MADE TO ENSURE ACCURACY, ALL LINEAR DIMENSIONS QUOTED ARE SUBJECT TO A +/- 3% VARIATION DUE TO THE MANUFACTURING PROCESS. PLEASE CALL FOR MORE INFORMATION IF REQUIRED.</small></p>	WYDALE PLASTICS Ltd		
	PROJECT: 350 Litre Flat		
DRAWN DATE: 07/03/2024	DESIGNED BY: SAMM	CHECKED BY:	
SHEET 1 OF 1	REV A	DRAWING NO:	