

MATERIALS	Polyethylene
NOMINAL WEIGHT (kg)	10
TYPICAL WALL THICKNESS (mm)	5.4

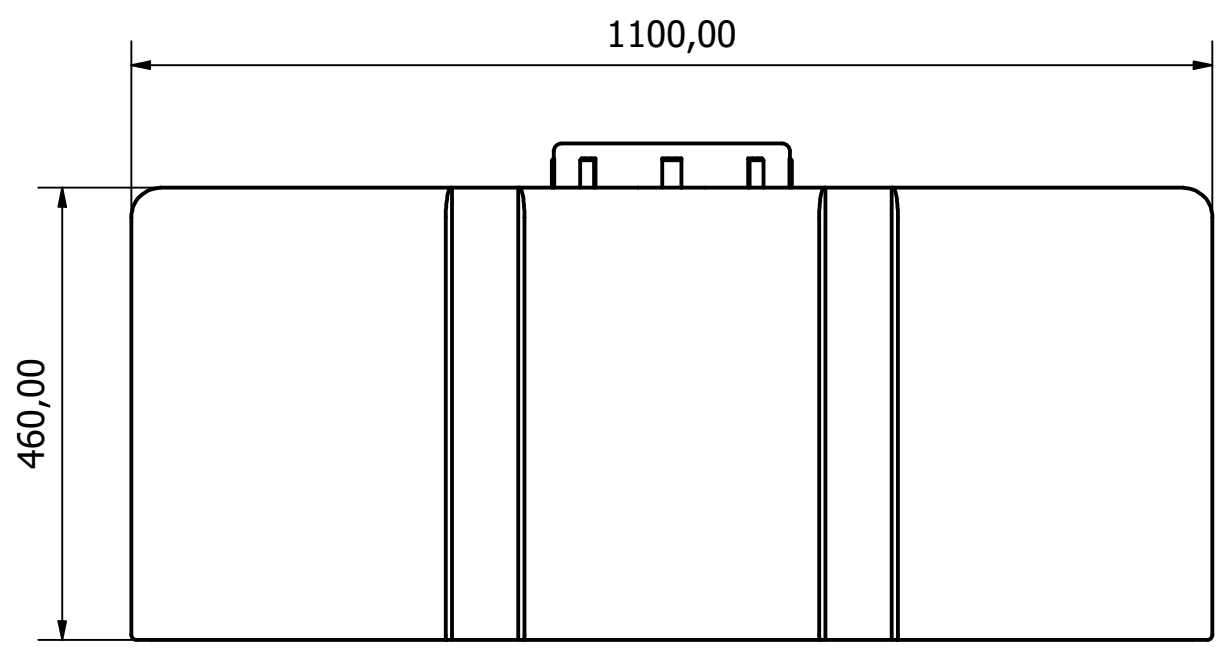
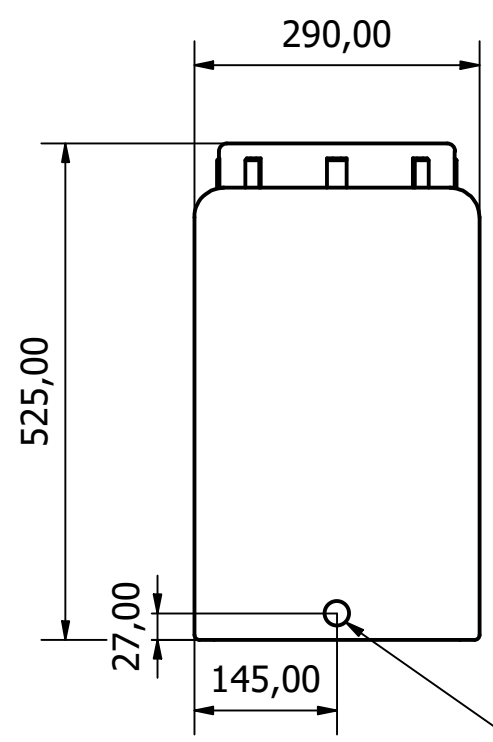
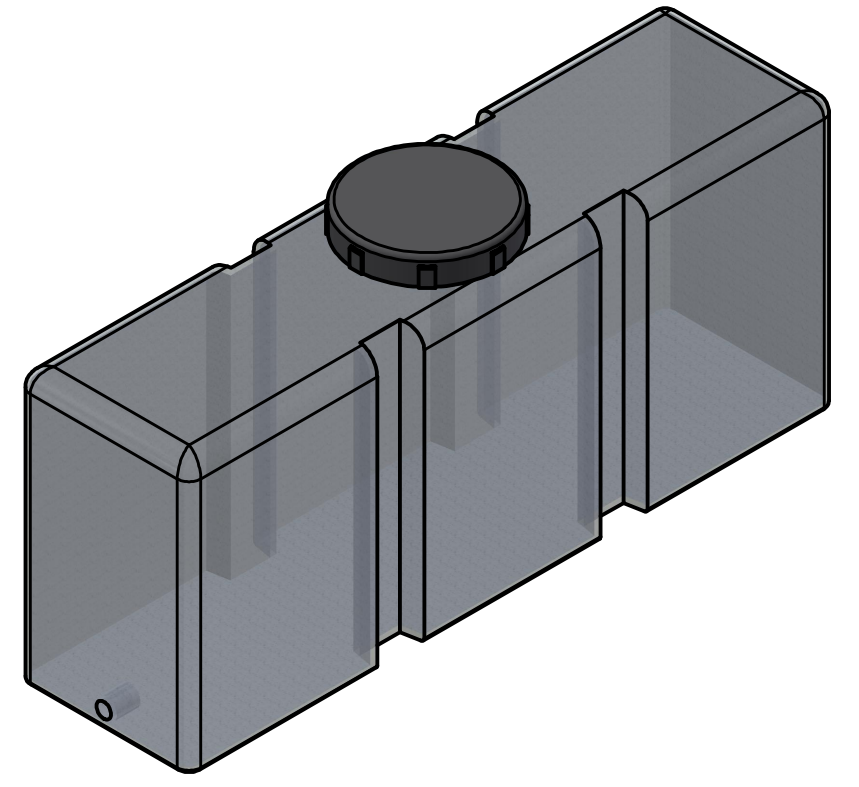
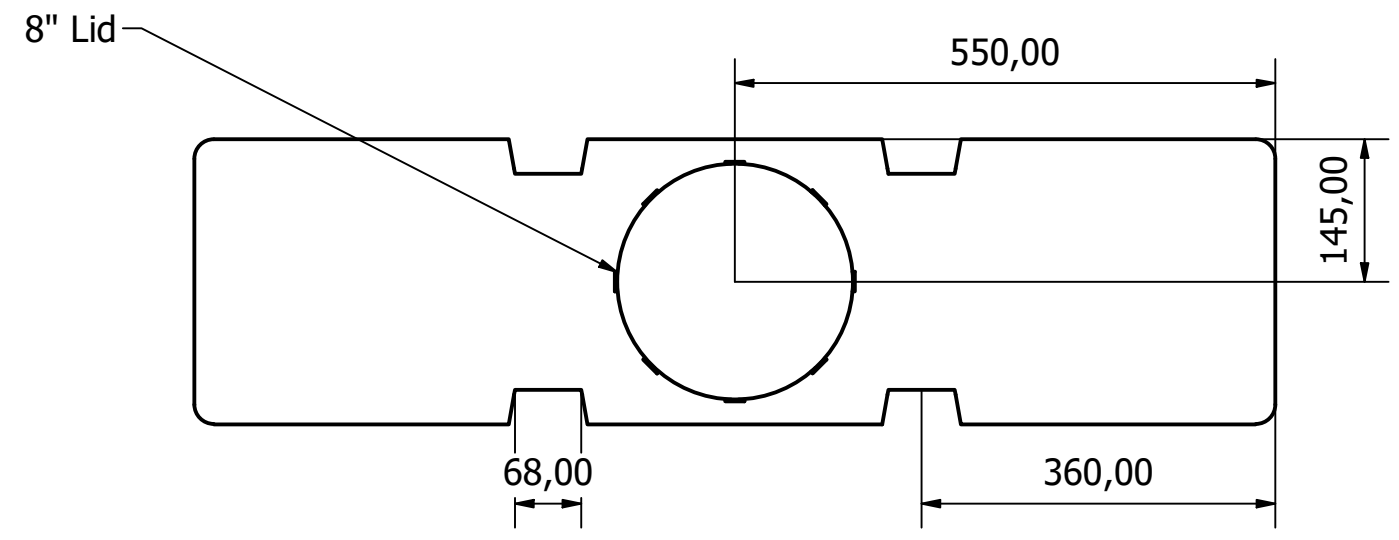

wydale
rotational moulding

Wydale Plastics Ltd
Cathole Bridge Rd,
Crewkerne,
Somerset,
TA18 8RF
Tel: 01460 73212
wydaleplastics.co.uk

THIS DRAWING AND THE INFORMATION THEREIN IS THE SOLE PROPERTY OF WYDALE PLASTICS LTD AND SHALL NOT BE COPIED OR REPRODUCED WITHOUT THE CONSENT OF WYDALE PLASTICS LTD. DIMENSIONS ARE ALL IN MM UNLESS OTHERWISE STATED. WHILST EVERY EFFORT IS MADE TO ENSURE ACCURACY, ALL LINEAR DIMENSIONS QUOTED ARE SUBJECT TO A +/- 3% VARIATION DUE TO THE MANUFACTURING PROCESS. PLEASE CALL FOR MORE INFORMATION IF REQUIRED.

WYDALE PLASTICS Ltd		
PROJECT:	125 Litre Upright	
DRAWN DATE:	DESIGNED BY:	CHECKED BY:
13/02/2024	SAMM	
SHEET 1 OF 1	REV A	DRAWING NO: